

No. 428

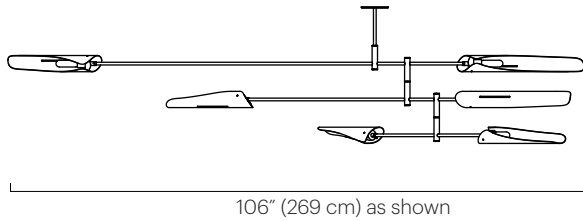

18" (46 cm) as shown

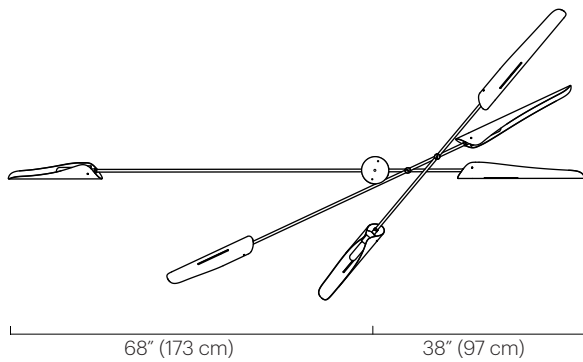

53.5" (136 cm) as shown



Description

The Sarus Mobile is a carefully balanced fixture, featuring three tiers of differing lengths. Each tier has one large and one small Sarus shade. Tiers scissor open when installed; arrangement is adjustable on site. Shades swivel 320° to cast light directionally.

Materials

Shades: Powder coated aluminum
 Frame: Plated steel
 Ceiling mount: Powder coated steel
 Drop: Plated steel

Shade Color

- Black Satin (ivory satin interior)
- Ivory Satin (ivory satin interior)

Finish

- Polished Nickel
- Brushed Brass

Lamping

120V: (6)T10 tubular incandescent medium base 60W max
 Note: Bulbs not included. Halogen bulbs not recommended.

Wattage

360 watts max

Weight

25 lbs (11.3 kg)

Remarks

Tier lengths cannot be customized. Due to the length of tiers, a natural arc occurs on the longest tier.

Remarks continued

Each tier has two shades. Ceiling mount consistent with shade color. Additional weight support recommended for junction box installation. Indoor use and dry locations only.

Dimensions

Tier 1: 106" (269 cm)
 Tier 2: 82" (208 cm)
 Tier 3: 69" (175 cm)
 Ceiling mount diameter: 5" (13 cm)
 Minimum overall height: 20" (51 cm)
 Large Shade: 23" L x 3" Ø (58 L x 8 Ø cm)
 Small Shade: 18" L x 3" Ø (46 L x 8 Ø cm)



Drop Kit

PARTS

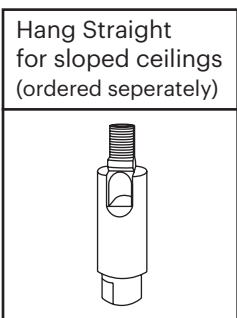
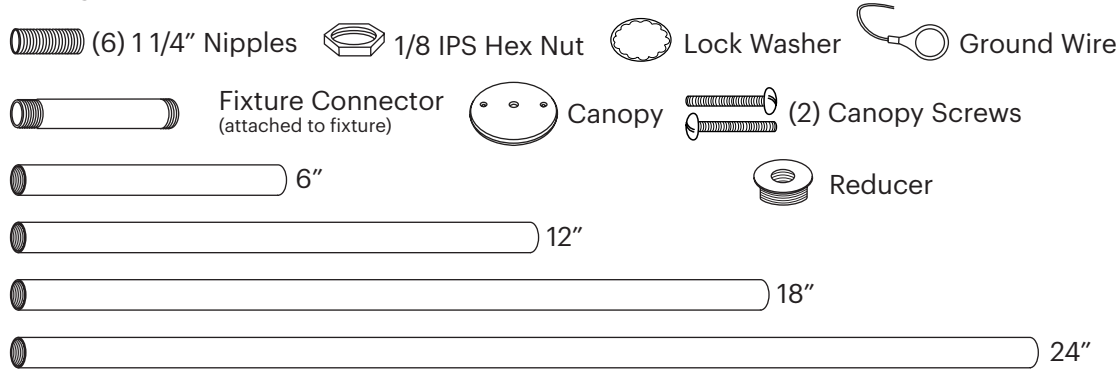

INSTRUCTIONS

Optional Parts:

Reducer: If replacing a drop on an **existing fixture** you may need to use the included reducer for the drop kit to fit the fixture's canopy. If the hole in the canopy is too large for the nipple to screw in – add the reducer as shown in the **Figure B**. The shoulder of the reducer should be on the top of the canopy.

Hang Straight: For **sloped ceilings** a 2" hang straight may be ordered. Screw the hang straight into the canopy followed by the nipple and drop as shown in **Figure B**.

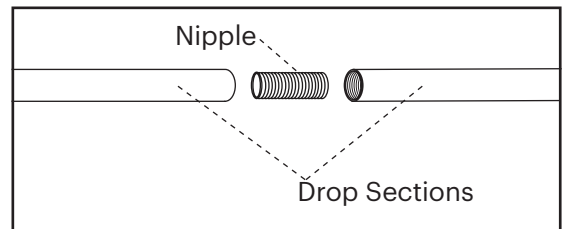

Figure A

1. Please read the specific fixture's installation instructions before assembling the drop kit or unwrapping the fixture. If using a drop kit as a replacement drop for an existing fixture attach the fixture connector to the top hub. Two people are required for installation.

2. The overall drop length is measured from the ceiling to the bottom of the fixture. To determine the best combination of drop lengths for your fixture and location refer to page 3.

3. Each section of tube will need to be connected with a nipple as in **Figure A**. **Determine the length of drop using the fixture specific information provided on page 3.** Each drop kit has a maximum of 5'2" from canopy to the top of the fixture - additional drop kits may be purchased. We recommend using the longest sections possible, with the longest section closest to the fixture.

4. Screw the drop sections and connectors together to finish assembly. **TIP:** Pull the wire through each section as you assemble. After you are sure of the length, we recommend using a drop of super glue or loctite on the threading of the nipples to help secure the connections.

5. Attaching the Canopy: Use reducer or hang straight if needed. Screw a nipple into the top of the last section of the drop and screw on the canopy. On the other side of the canopy, add a ground wire, lock washer and secure with a hex nut.

6. Follow the fixture specific installation instructions.

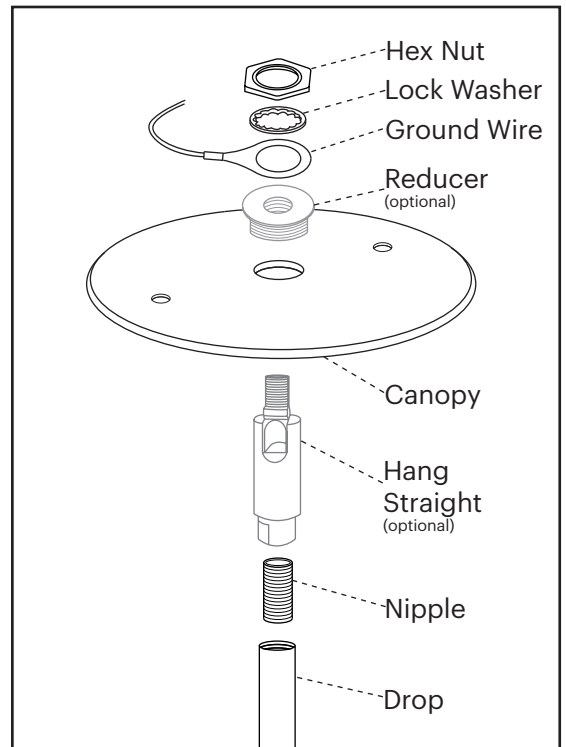

Figure B

DROP LENGTH FORMULA:

Ceiling Height - Fixture Height (18") - Height Above Floor = Drop Kit Length

*Hang Straight will add an additional 2"

SUGGESTED HEIGHT ABOVE FLOOR:

In open room: 84" above floor.

Above a table: 76" above floor.

OVERALL DROP LENGTH COMBINATIONS

| | fixture | drop kit |
|---------------------------------------------------|-----------|----------|
| 20" = 2" Fixture Connector (already attached) | 18" + 2" | |
| 26" = 6" + 2" Fixture Connector | 18" + 8" | |
| 32" = 12" + 2" Fixture Connector | 18" + 14" | |
| 38" = 18" + 2" Fixture Connector | 18" + 20" | |
| 44" = 24" + 2" Fixture Connector | 18" + 26" | |
| 50" = 6" + 24" + 2" Fixture Connector | 18" + 32" | |
| 56" = 12" + 24" + 2" Fixture Connector | 18" + 38" | |
| 62" = 18" + 24" + 2" Fixture Connector | 18" + 44" | |
| 68" = 6" + 18" + 24" + 2" Fixture Connector | 18" + 50" | |
| 74" = 12" + 18" + 24" + 2" Fixture Connector | 18" + 56" | |
| 80" = 6" + 12" + 18" + 24" + 2" Fixture Connector | 18" + 62" | |

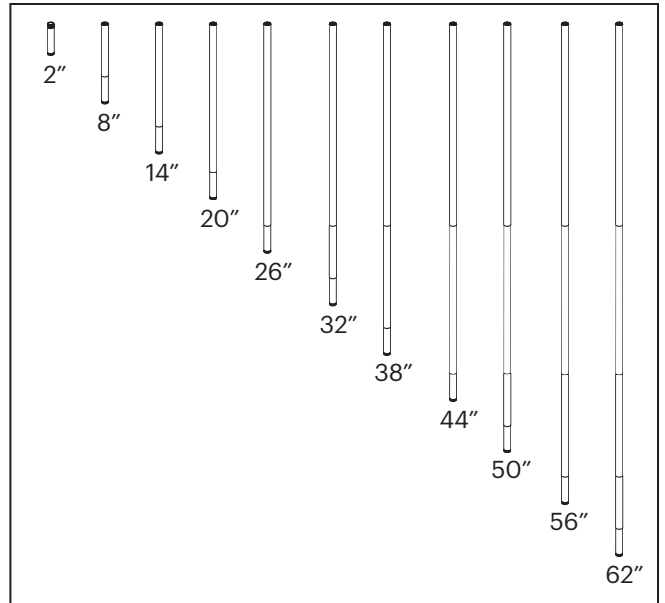

EXAMPLES

